

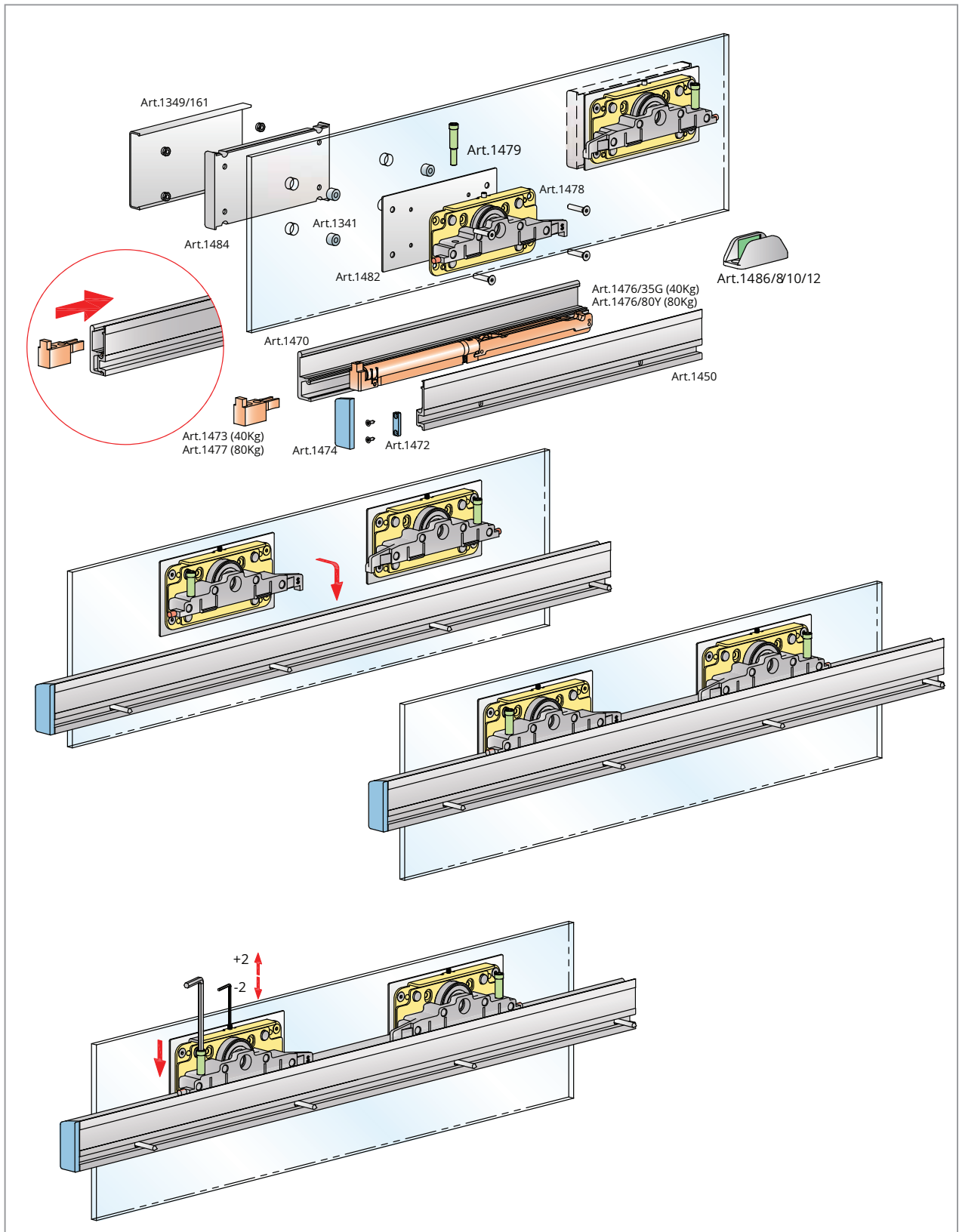

Diva Air

Innovative sliding system with amortised stopper for glass doors.
Exposed sliding track.



SIZE DESCRIPTION

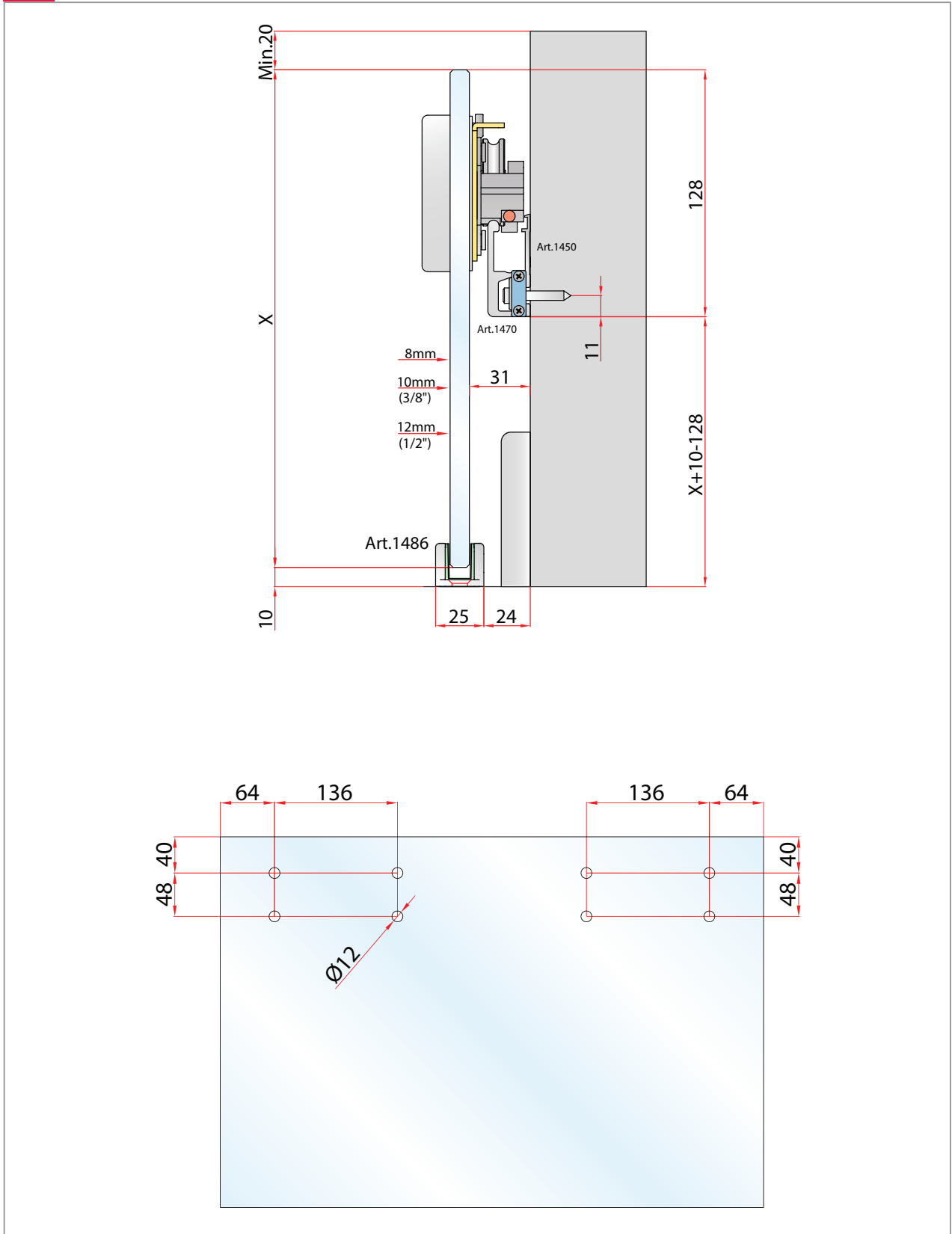

KIT FOR GLASS DOOR

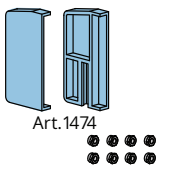
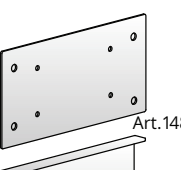
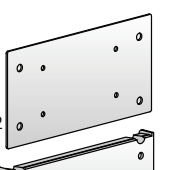
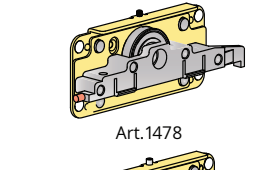
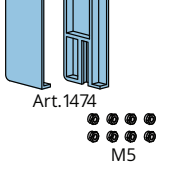
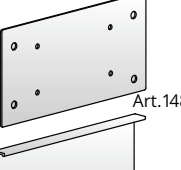
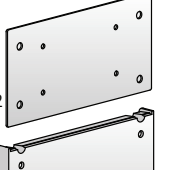
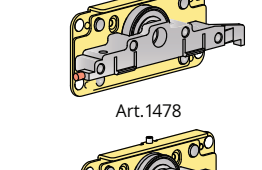
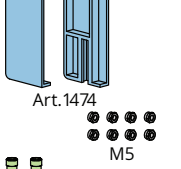
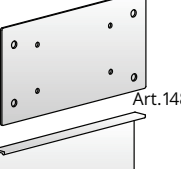
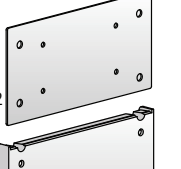
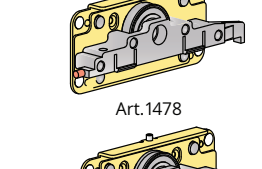
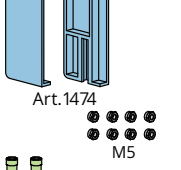
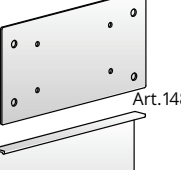
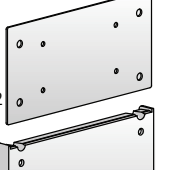
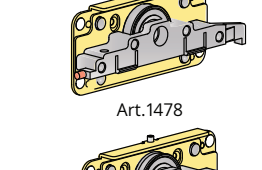
<p>DOOR WITH SOFT CLOSING 40 Kg</p>	<p>ART.1478/1349/35G/A ART.1478/1349/35G/B ART.1478/1349/35G/N ART.1478/1349/35G/E3 ART.1478/1349/35G/AL ART.1478/1349/35G/AT</p>	 <p>Art.1474 AUTOBLOCM5</p>	 <p>Art.1482</p>	 <p>Art.1478 Art.1476/35G</p>	 <p>Art.1478 Art.1476/35G</p>
<p>DOOR WITH SOFT CLOSING 80 Kg</p>	<p>ART.1478/1349/80Y/A ART.1478/1349/80Y/B ART.1478/1349/80Y/N ART.1478/1349/80Y/E3 ART.1478/1349/80Y/AL ART.1478/1349/80Y/AT</p>	 <p>Art.1474 M5</p>	 <p>Art.1482</p>	 <p>Art.1478 Art.1676/80Y</p>	 <p>Art.1478 Art.1676/80Y</p>
<p>DOOR WITH CLASSIC STOPPER 40 Kg</p>	<p>ART.1478/1349/P40/A ART.1478/1349/P40/B ART.1478/1349/P40/N ART.1478/1349/P40/E3 ART.1478/1349/P40/AL ART.1478/1349/P40/AT</p>	 <p>Art.1474 M5</p>	 <p>Art.1482</p>	 <p>Art.1478 Art.1473</p>	 <p>Art.1478 Art.1473</p>
<p>DOOR WITH CLASSIC STOPPER 80 Kg</p>	<p>ART.1478/1349/P80/A ART.1478/1349/P80/B ART.1478/1349/P80/N ART.1478/1349/P80/E3 ART.1478/1349/P80/AL ART.1478/1349/P80/AT</p>	 <p>Art.1474 M5</p>	 <p>Art.1482</p>	 <p>Art.1478 Art.1477</p>	 <p>Art.1478 Art.1477</p>

DESCRIPTION OF PIERCING FOR UPRIGHT BARS

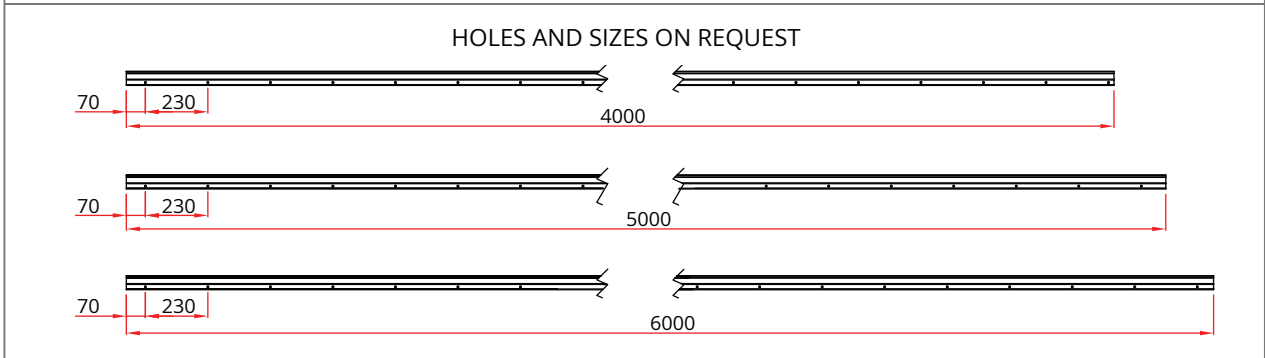
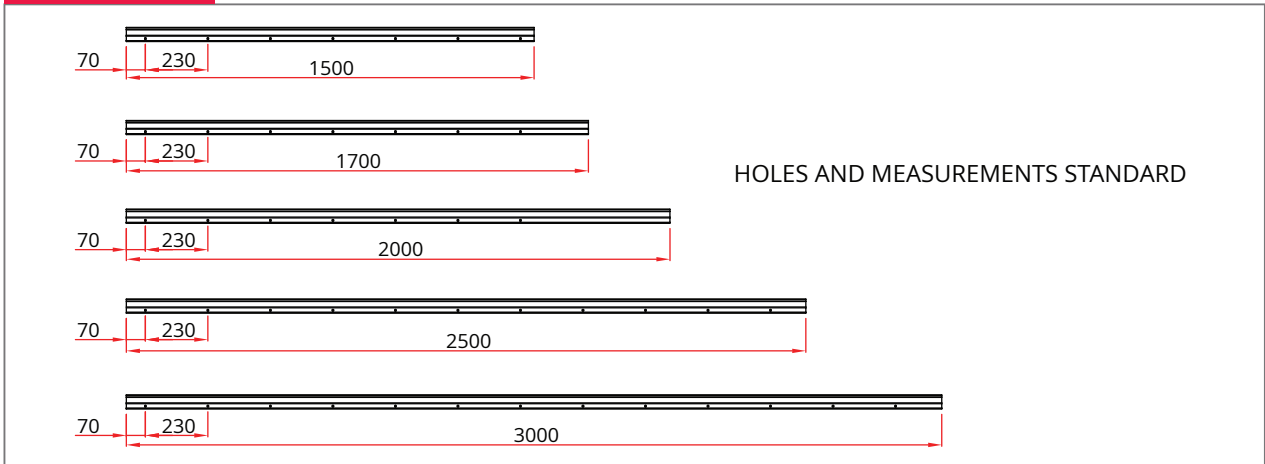

Specify article number, length and color when ordering

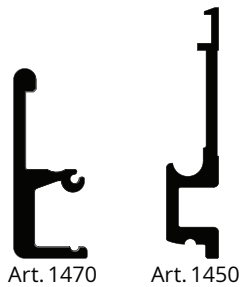

- A = Anodized silver
- B = Anodized bronze
- N = Electricolor black
- E3 = Electricolor 3 (Coffee)
- AL = Polished steel
- AT = Titanium steel

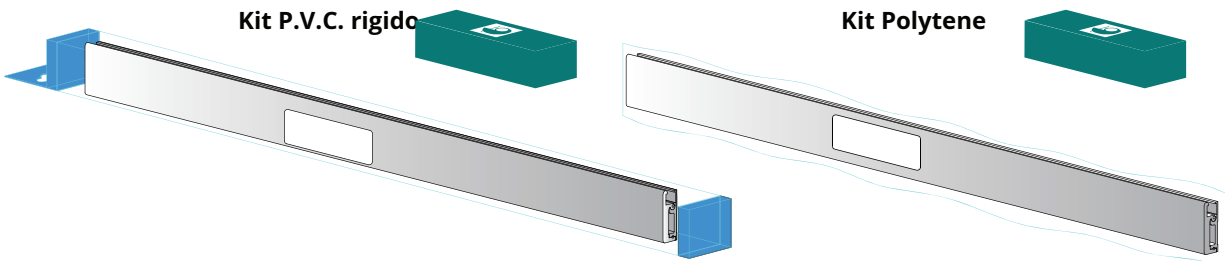

The pair of tracks can be requested packed in blister pack (P.V.C. rigido o Polytene).
Specify length, Color and Article number

DOUBLE DOOR



- 1) ADJUST THE SLIDERS FOR ALIGNMENT OF THE DOORS
- 2) ADJUST THE SOFT CLOSING TO PREVENT COLLISION OF THE DOORS

