

TOOLS NEEDED

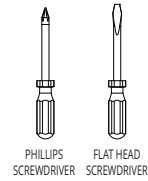

REPLACING AN EXISTING LOCK (No door preparation Necessary)

1 INSTALL LATCH

Insert latch into the door edge and tap lightly into place. Turn latch tongue according to strike handing, before installing face plate.

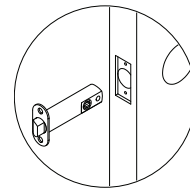

2 ATTACH FACE PLATE

Insert latch into the door edge and tap lightly into place. Turn latch tongue according to strike handing, before installing face plate.

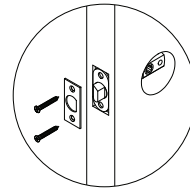

3 INSTALL STRIKE PLATE

- A Secure the latch strike to the jamb using wood strike screws provided.
- B If there is no strike prep, mark a centerline on the door jamb that aligns with the centerline of the door latch. Drill one 1"(25mm) hole 5/8"(16mm) deep.
- C Use the D strike plate to make an outline on the door jamb and chisel 1/8"(3mm) deep until it sits flush.
- D Drill two 1/8"(3mm) holes then secure strike with screws provided.

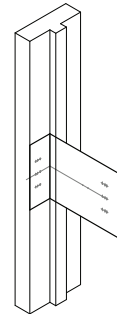

4 INSTALL LOCKSET

- A Insert Exterior Side (with two female threaded posts) guiding the spindle into the latch.
- B Remove interior cover cap from the tabs provided.
- C Insert Interior Side guiding the spindle into the latch.
- D While holding together insert the two screws provided, from interior side with guide holes provided and secure the lockset to the door.
- E Clip on cover cap to conceal screws. Slip rose cover over lever handle and guide into rose, and press to engage clip to secure.

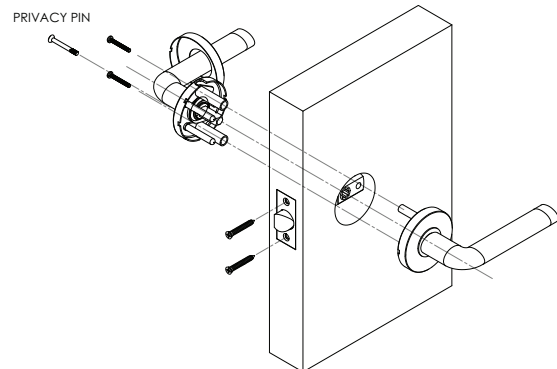

DOOR PREPARATION TEMPLATE

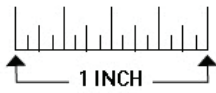

Drill a 1" (25mm) diameter hole at the centre of the door edge

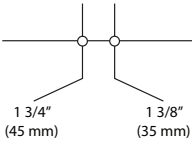

IMPORTANT: Print template to scale if not factory supplied instructions.

Fold here
Place on the door edge

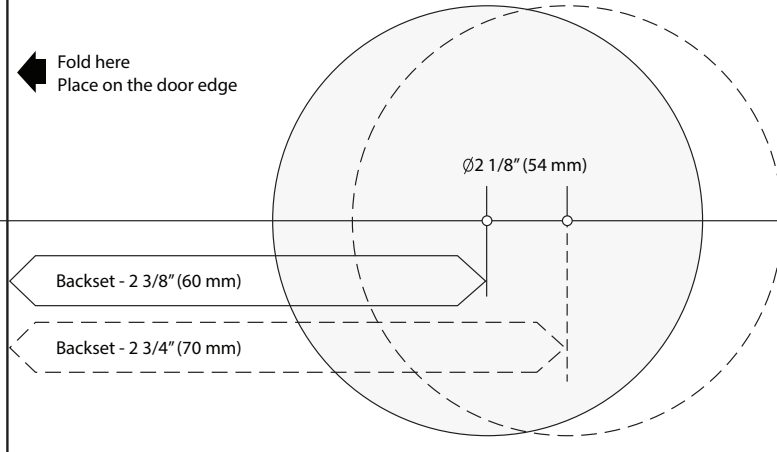

TOOLS NEEDED

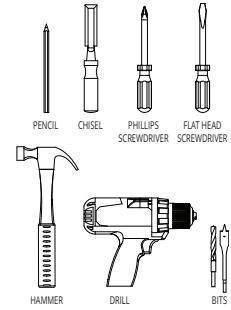

NEW DOOR PREPARATION

1 USE TEMPLATE PROVIDED TO MARK CENTER HOLES ON THE DOOR

Determine latch backset (2 3/8" or 2 3/4"). Fold enclosed template on dotted line and locate on door at desired height. If door is bevelled, place folded edge on low side of bevel.

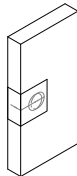

2 MARK DOOR

Mark door at points 1, 2, 3 and 4 and centre punch for drilling.

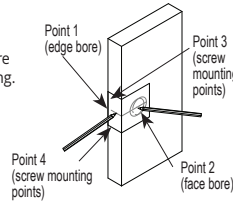

3 DRILL EDGE BORE

Drill 1" dia. hole. 2 3/8" backset... drill 3 5/8" deep. 2 3/4" backset... drill 4" deep

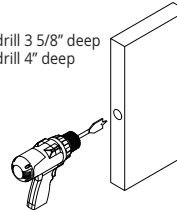

4 DRILL FACE BORE

2 1/8" dia. drill bit. Keep drill perpendicular to door surface and drill through.

Note: for wood doors: to avoid splintering, drill a centering hole through the door, then drill face bore from both sides.

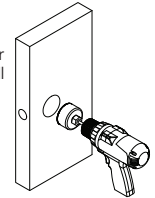

5 POSITION FACEPLATE

Position finished faceplate over latch. Slide latch into edge bore. Check that screw mounting points are centered before tracing the outline of the finished faceplate.

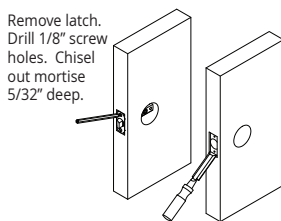

6 CHISEL MORTISE

Remove latch. Drill 1/8" screw holes. Chisel out mortise 5/32" deep.

7 INSERT LATCH

With "UP" side up, slide latch into edge bore.

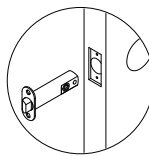

8 ATTACH FACEPLATE

Rotate head so angled side is toward strike when door closes. Position finished faceplate and fasten with two screws.

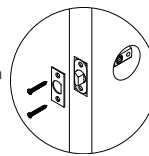

9 INSTALL STRIKE

IMPORTANT Before installing Strike, please mount hardware as shown in drawing.

Using strike template, mark jamb, drill screw holes and chisel mortise at proper location. Install strike.

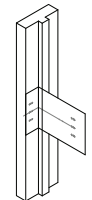

SEE PAGE 1 FOR LOCK INSTALLATION INSTRUCTIONS

HANDLE CARE

Wash and clean only with water and polish with a soft clean non abrasive cloth.

LIFETIME MECHANICAL AND FINISH WARRANTY

The product is warranted to be free from finish, mechanical and workmanship defects for the life of the product. Linear Interior Systems Inc. will replace any Linear T300 Series Lockset which fails to meet this warranty. Any finish deterioration from use of paints, solvents or chemicals is not a defect and therefore not covered by this warranty.

Linear will not be liable for any incidental damages. In the event that your Linear Lock does not meet the warranted quality, return the product with proof of purchase to the dealer you purchased it from.