

48-400-CR

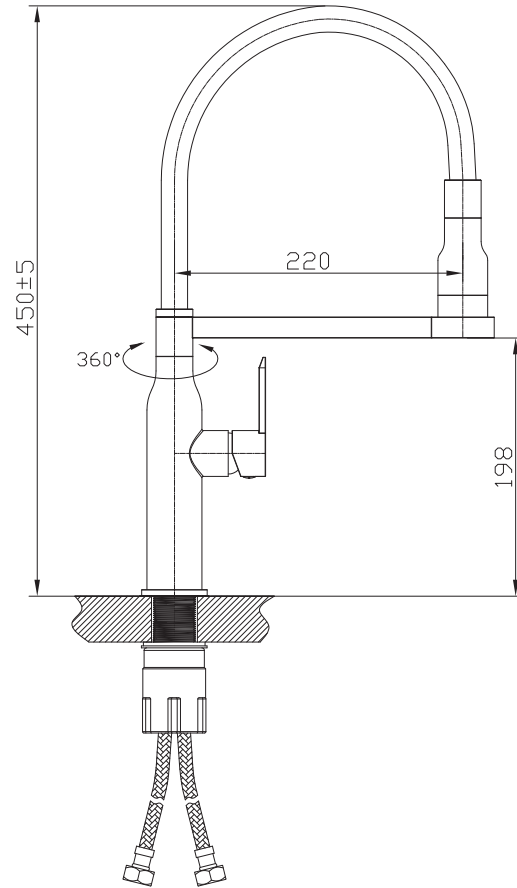

Single Lever Sink Mixer

Features:

- ▶ Single lever multi function
- ▶ Ceramic Disk Cartridge
- ▶ Braided supply lines included
- ▶ Flow Rate: 1.8~2.2 GPM
- ▶ Factory pressure tested
- ▶ cUPC Certified

Available Finishes:

- ▶ Polished Chrome

