

LINEAR

INTERIOR SYSTEMS INC.

Magic²

VETRO

The original invisible sliding doors system
Il sistema invisibile originale per porte scorrevoli

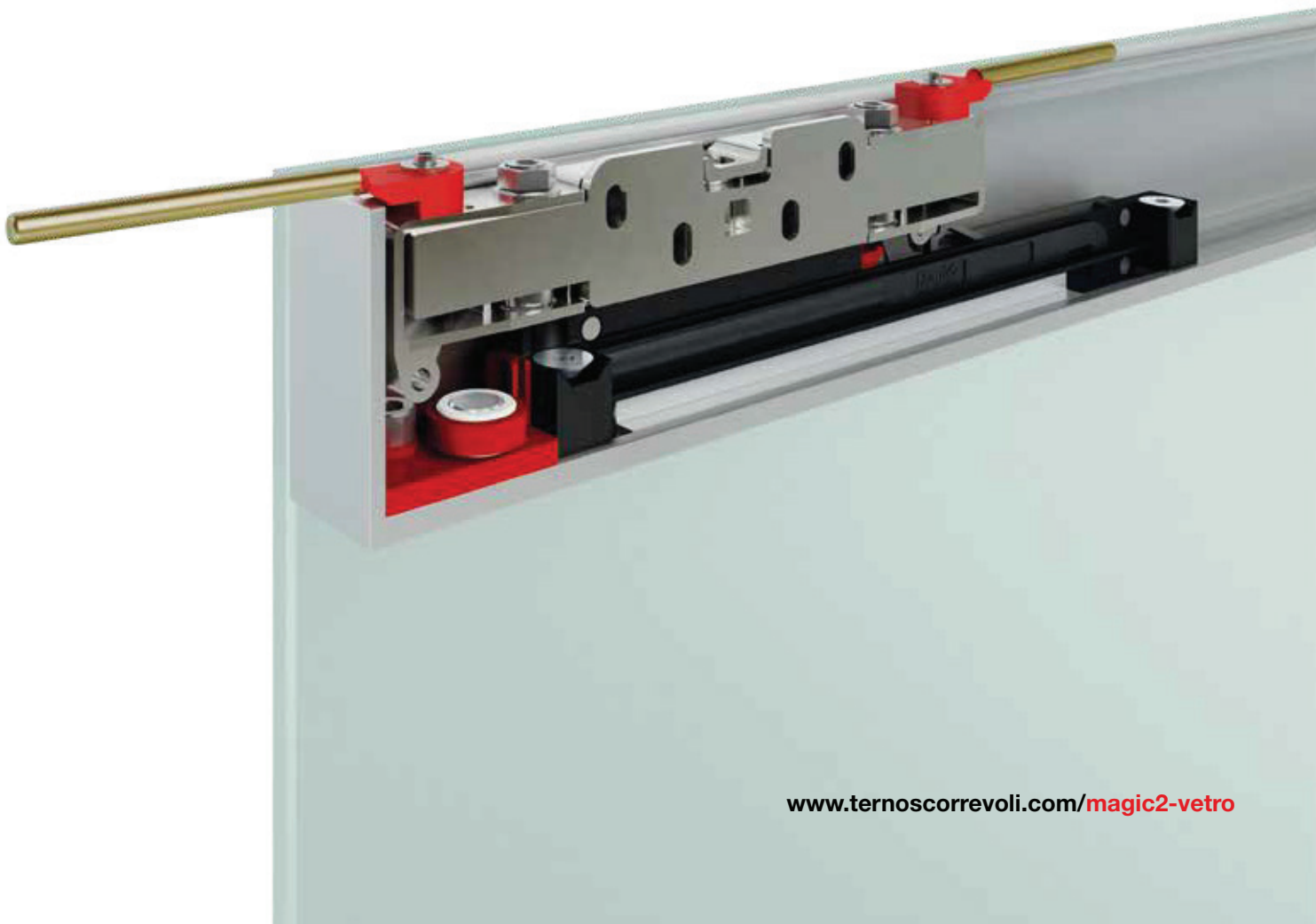



Magic2 Vetro

COMPLETE BOX KIT / KIT COMPLETO IN SCATOLA



K	Complete kit / Kit completo	
	.	
	0041	1100 mm - 80kg
	0042	1800 mm - 80kg
	.	
	1	Glass thk. / Vetri sp. 8 mm (5/16")
	2	Glass thk. / Vetri sp. 10 mm (3/8")
	3	Glass thk. / Vetri sp. 12 mm (1/2")
	.	
	02	Brushed Anodized Silver / Argento Spazzolato

EXAMPLE / ESEMPIO

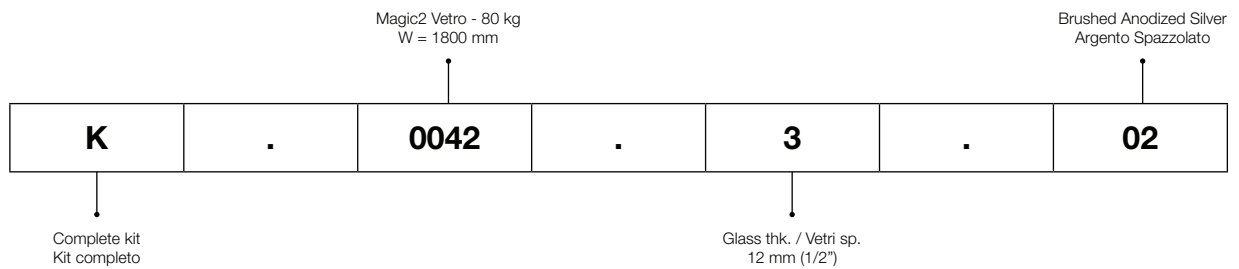

Magic2

VETRO

PATENTED

Magic2 Vetro is the new **PATENTED** and **INVISIBLE** sliding door system outside the wall with soft-closing. The system might be fixed with exposed studs or bundle and it is suitable to monolithic or laminated glasses, from 8 up to 12,7 mm of thickness.

Magic2 Vetro è l'innovativo **SISTEMA INVISIBILE BREVETTATO** per porte scorrevoli in vetro esterno muro con fermi ammortizzati. Il sistema può essere fissato tramite borchie o fascia a vista ed è adatto per vetri monolitici o stratificati, con spessore da 8 a 12,7 mm.



dressing rooms



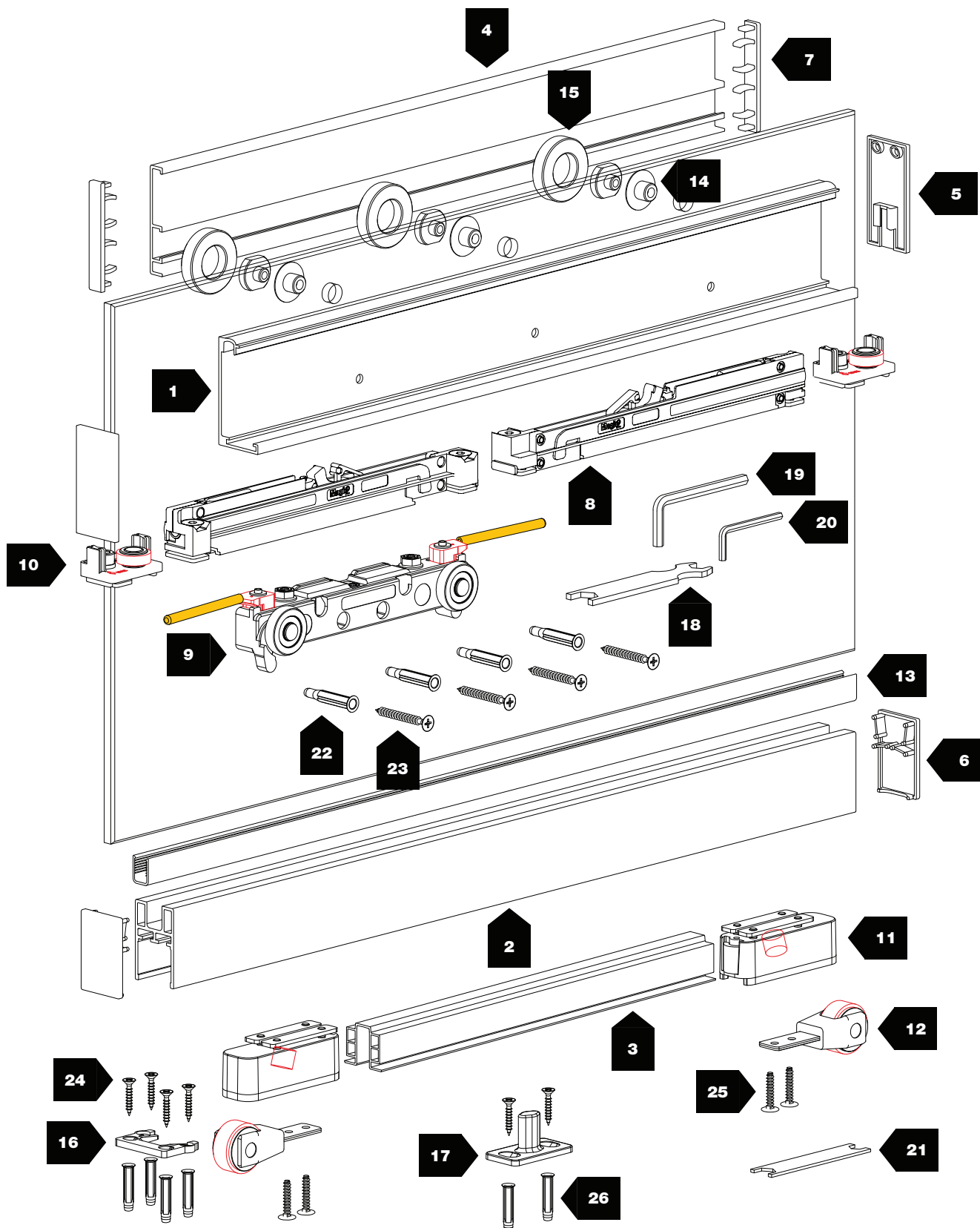











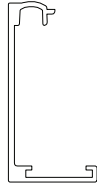
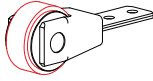

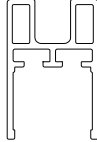



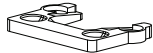

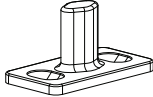
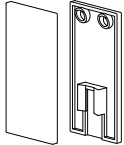
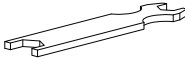
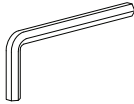
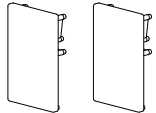
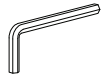
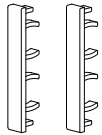

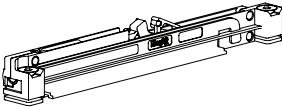
680 ÷ 1800 mm

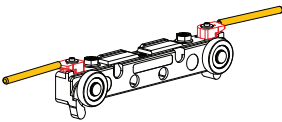

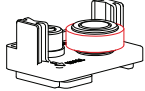
80 kg

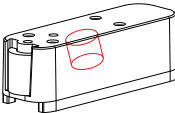

10 mm

N°	Barcode		kg		N°	Barcode		kg	
1	2850		-		12	2857		-	
2	2863		-	Glass thk. Vetri sp. 8 mm (5/16")	13	2193		-	
	2862			Glass thk. Vetri sp. 10 mm (3/8")	14	2195		-	
	2861			Glass thk. Vetri sp. 12 mm (1/2")	15	2197/A		-	
3	2860		-		16	2859		-	
4	2198		-		17	2855		-	
5	2851/N		-		18	1025		-	
	2851/A				19	538		-	
6	2866		-		20	654		-	
7	2199		-		21	1164		-	
8	2864-80		80		22	FISCHER UX6		-	
9	2852		80		23	4,5x40		-	
10	2856		-		24	4x30		-	
11	2858		-		25	4x20		-	
					26	FISCHER SX5		-	



80 kg



N.2 Soft damper stoppers
N.2 Fermi ammortizzati



Customizable door width
Larghezza porta personalizzabile



Patented system
Sistema brevettato



Brushed Anodized Silver
Argento Spazzolato

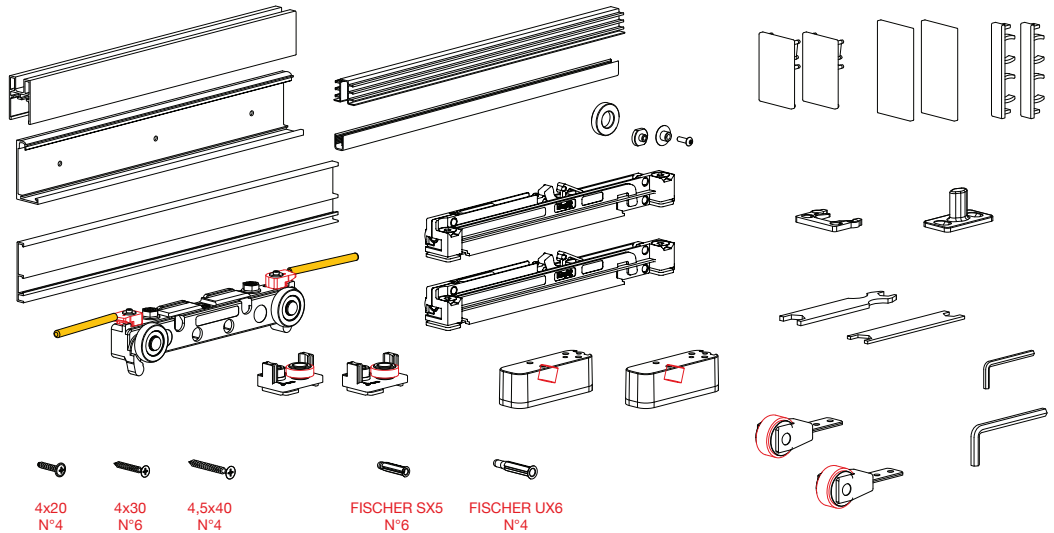

4x20 N°4 4x30 N°6 4,5x40 N°4

FISCHER SX5 N°6 FISCHER UX6 N°4

OLD CODE	NEW CODE			
MAGIC2/1100/V/08	K.0041.1.02	8 mm (5/16")	1100 mm	6x
MAGIC2/1100/V/10	K.0041.2.02	10 mm (3/8")		6x
MAGIC2/1100/V/12	K.0041.3.02	12 mm (1/2")		6x
MAGIC2/1800/V/8	K.0042.1.02	8 mm (5/16")	1800 mm	4x
MAGIC2/1800/V/10	K.0042.2.02	10 mm (3/8")		4x
MAGIC2/1800/V/12	K.0042.3.02	12 mm (1/2")		4x

MEASUREMENTS DESCRIPTION / DESCRIZIONE MISURE

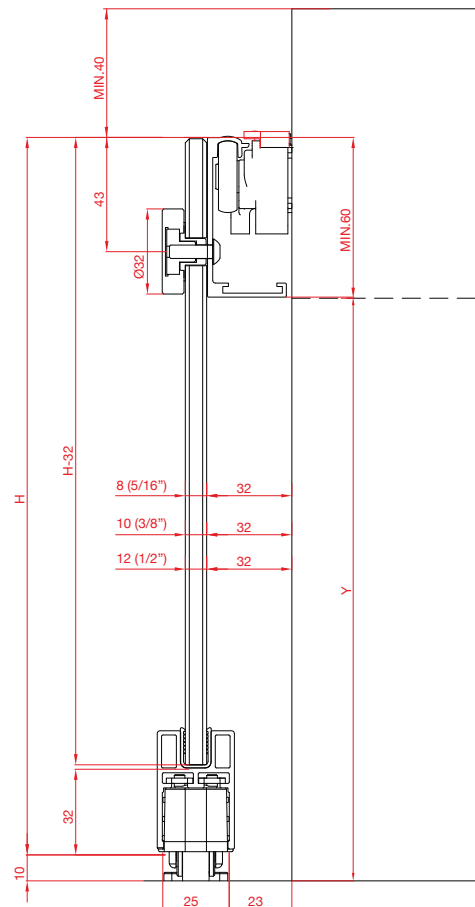
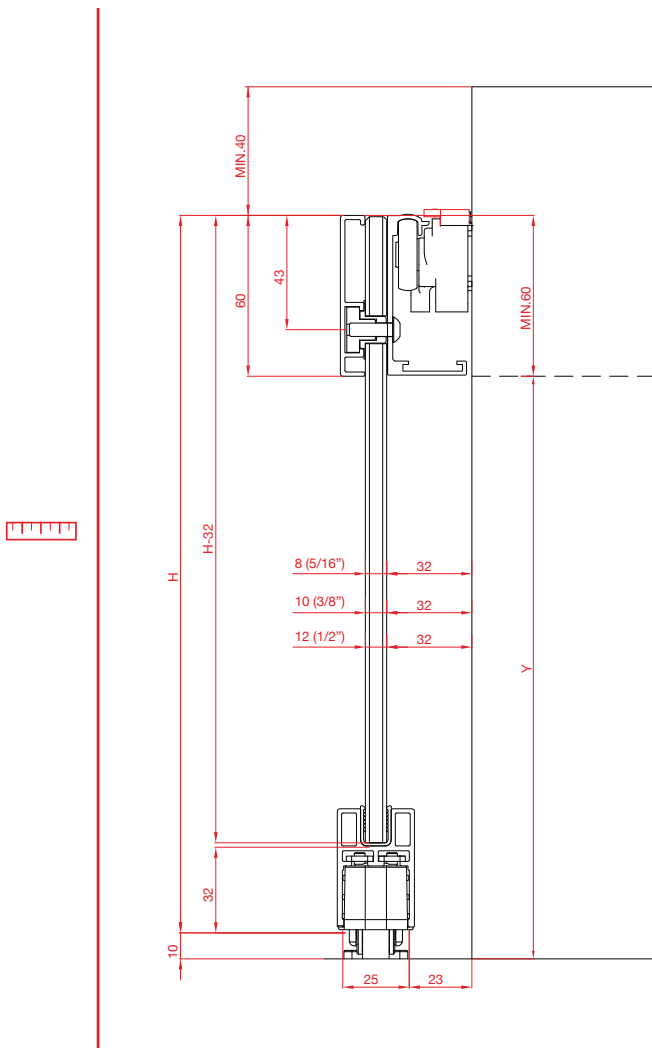

MILLING DESCRIPTION / DESCRIZIONE DELLE LAVORAZIONI

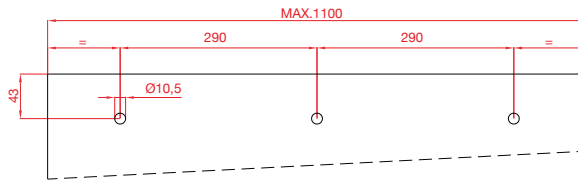

1100 mm

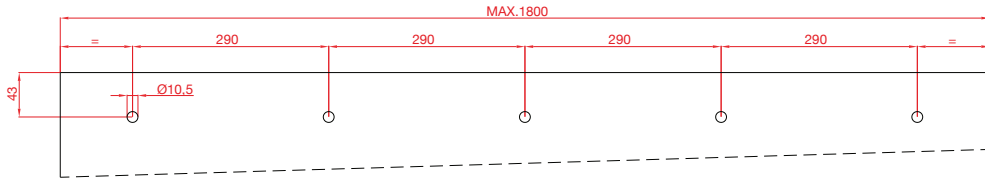

1800 mm

PROFILES CUTTING MEASUREMENTS / MISURE DI TAGLIO DEI PROFILI

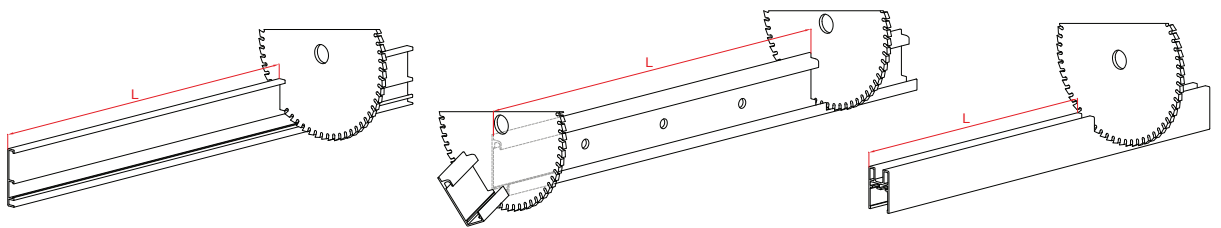

ART. 2199

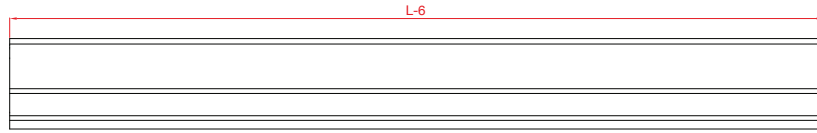

ART. 2198

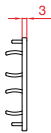

ART. 2199



ART. 2851

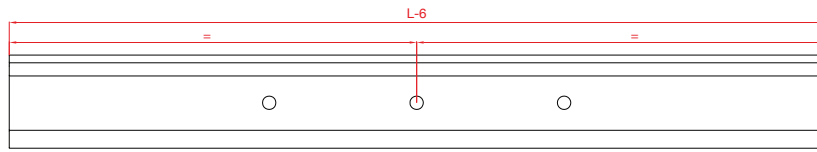

ART. 2850



ART. 2851

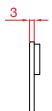

ART. 2866

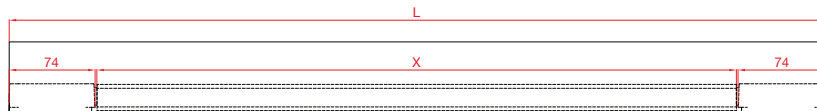

ART. 2863 - ART. 2862 - ART. 2861

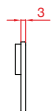

ART. 2866

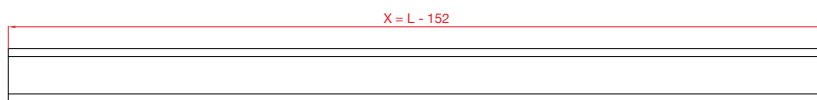

ART. 2860



ACCESSORIES PLACEMENT (TOTAL OPENING POSITION) / POSIZIONAMENTO DEGLI ACCESSORI (POSIZIONE APERTURA TOTALE)

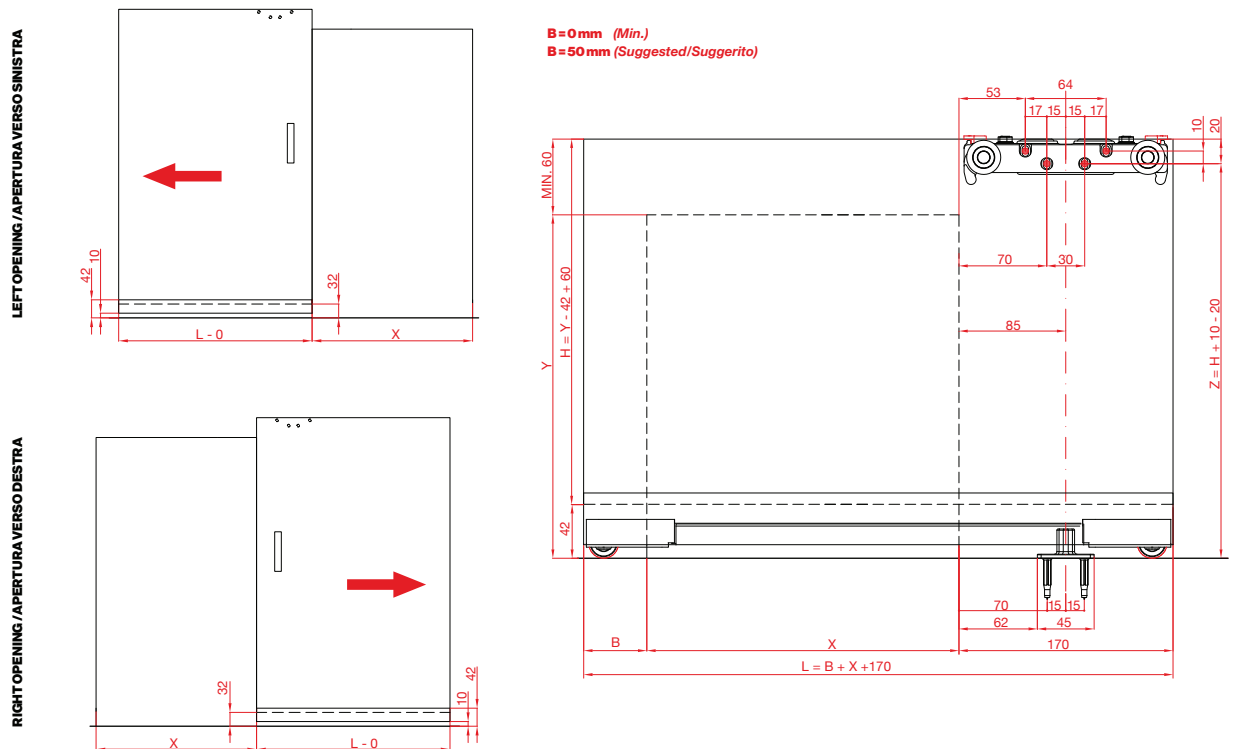

B=0mm (Min.)
B=50mm (Suggested/Suggerito)

**MAGIC2/1100/V/08 (K.0041.1.02) - MAGIC2/1100/V/10 (K.0041.2.02) -
MAGIC2/1100/V/12 (K.0041.3.02)**

B=0
X= MIN. 680 (L=850)
X= MAX. 930 (L=1100)

B=50
X= MIN. 680 (L=900)
X= MAX. 880 (L=1100)

**MAGIC2/1800/V/8 (K.0042.1.02) - MAGIC2/1800/V/10 (K.0042.2.02) -
MAGIC2/1800/V/12 (K.0042.3.02)**

B=0
X= MIN. 680 (L=850)
X= MAX. 1630 (L=1800)

B=50
X= MIN. 680 (L=900)
X= MAX. 1580 (L=1800)

ART. 2859 - END STOPPER / FINE CORSA

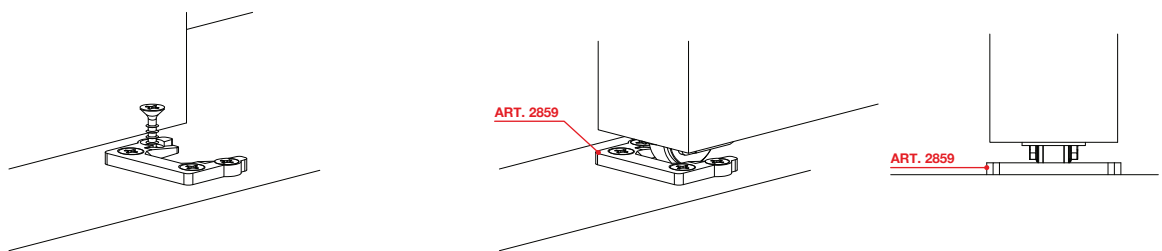

**ALUMINIUM TRACK FOR IRREGULAR FLOOR
PROFILO IN ALLUMINIO PER PAVIMENTAZIONE IRREGOLARE**

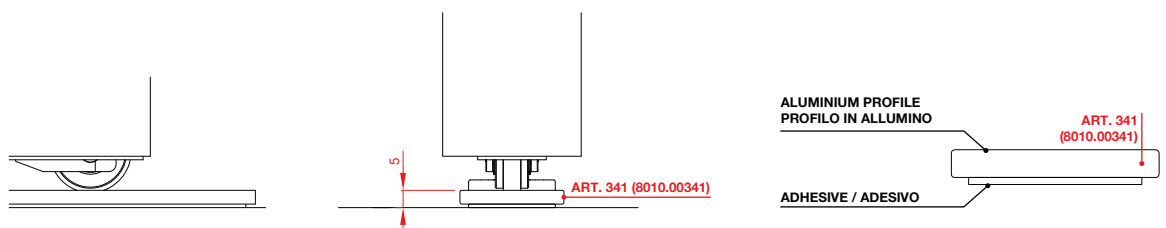

ART. 341
8 01 0 .00341



LINEAR

INTERIOR SYSTEMS INC.

1 SARAMIA CRESCENT
CONCORD, ON, L4K 3S6
CANADA

T: 905.265.0055 | INFO@LINEARINTERIORSYSTEMS.COM