



I N S T A L L A T I O N G U I D E

Contents

1 Toolings	1
2 Components	1
3 Guiding for each component	1
3.1 Wall starter	2
3.2 Top connection and bottom connection	2
3.3 Panels fixing	3
3.3.1 Connection between glass to glass	3
3.3.2 Connection between wood panel to wood panel	4
3.3.3 Connection between glass to wood panel	5
3.4 Cover fixing for top and bottom connection	5
3.5 Door fixing	6-7
3.6 Special place fixing	8
3.6.1 T connection	8-9
3.6.2 L connection	9
3.6.3 Wood panels corner	10

1 Toolings

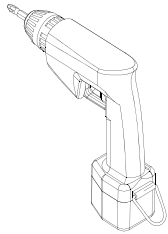

Electric drill

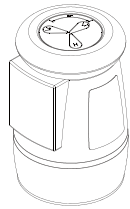

Gradienter

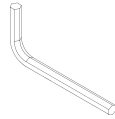

Allen key

2 Components

Wall starter for glass panel

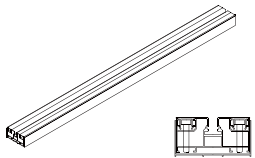

Wall starter for solid panel

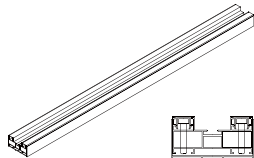

Ceiling and bottom connection for glass panel

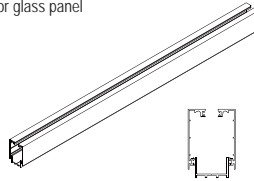

Ceiling and bottom connection for wood panel

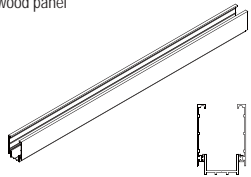

Glass panel

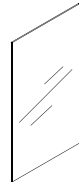

Solid panel



Corner connection for solid panel



Glass door frame

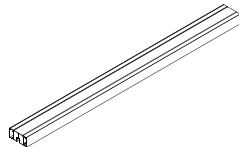

Solid door frame

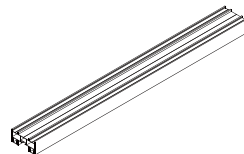

3 Component installation

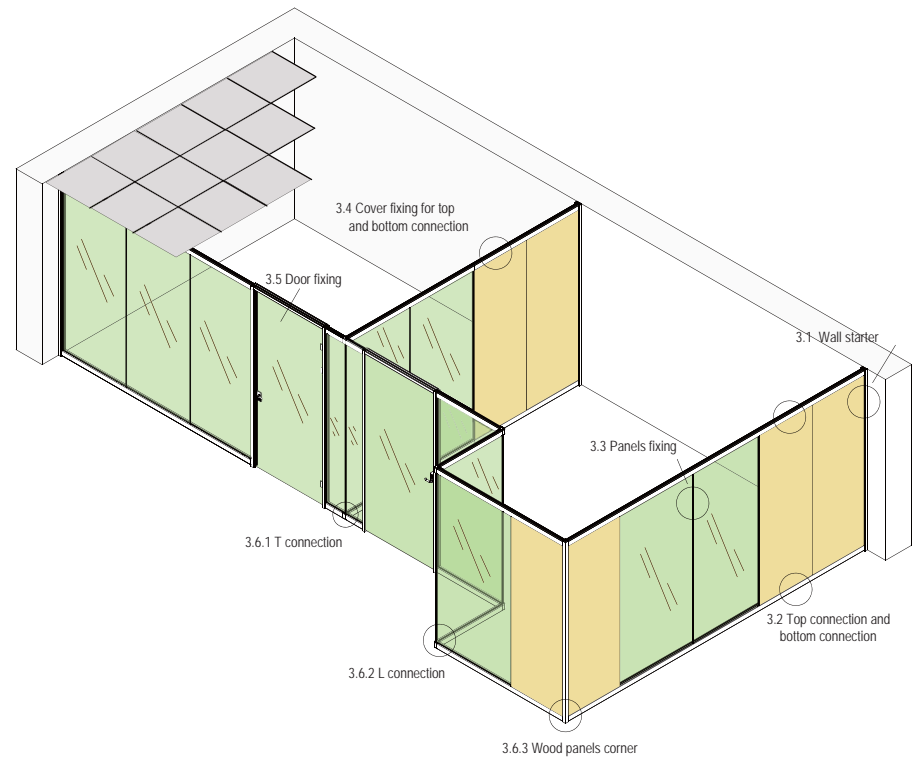

3.1 | Wall starter

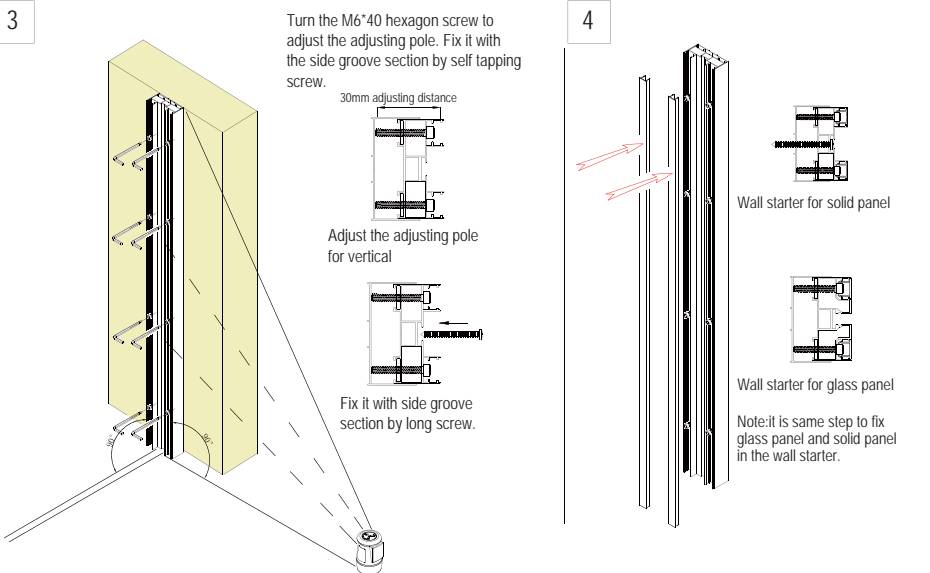
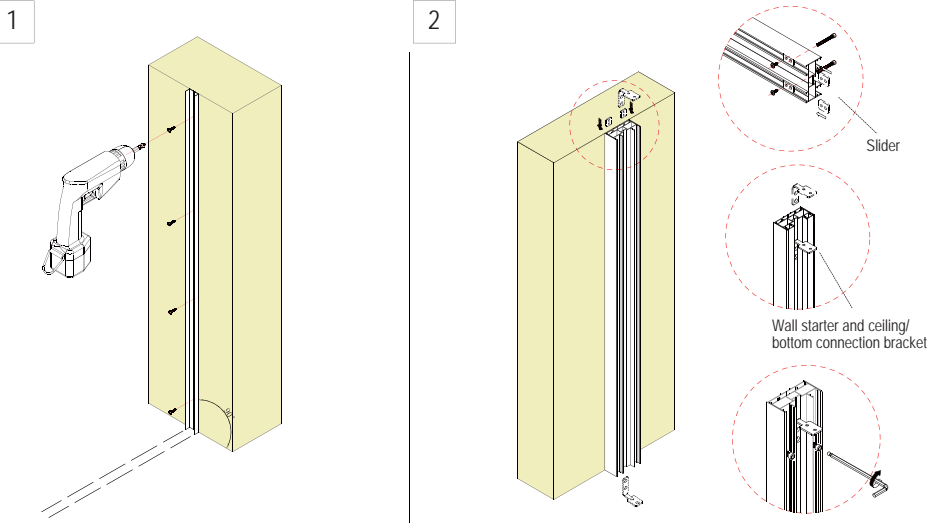

3.2 | Top connection and bottom connection

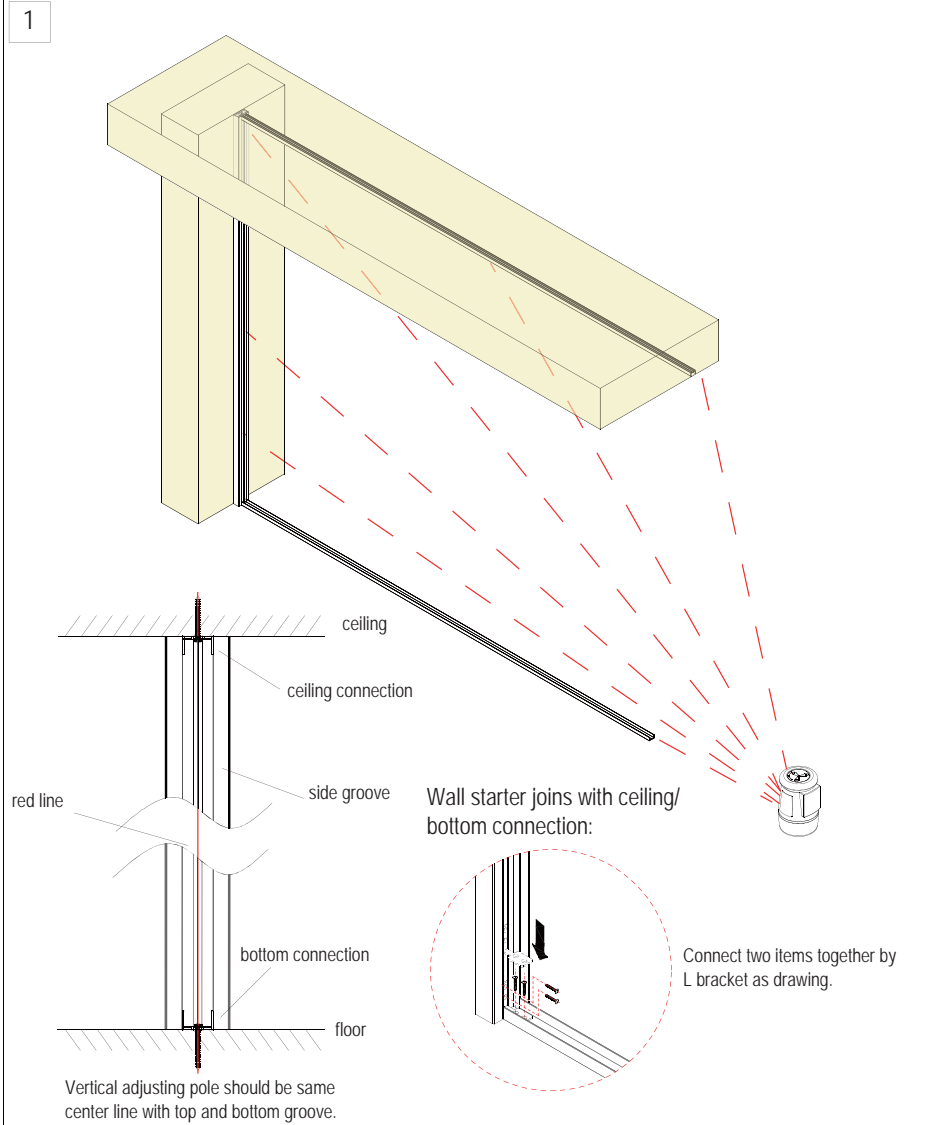

3.3.1 Connection and adjustment between glasses

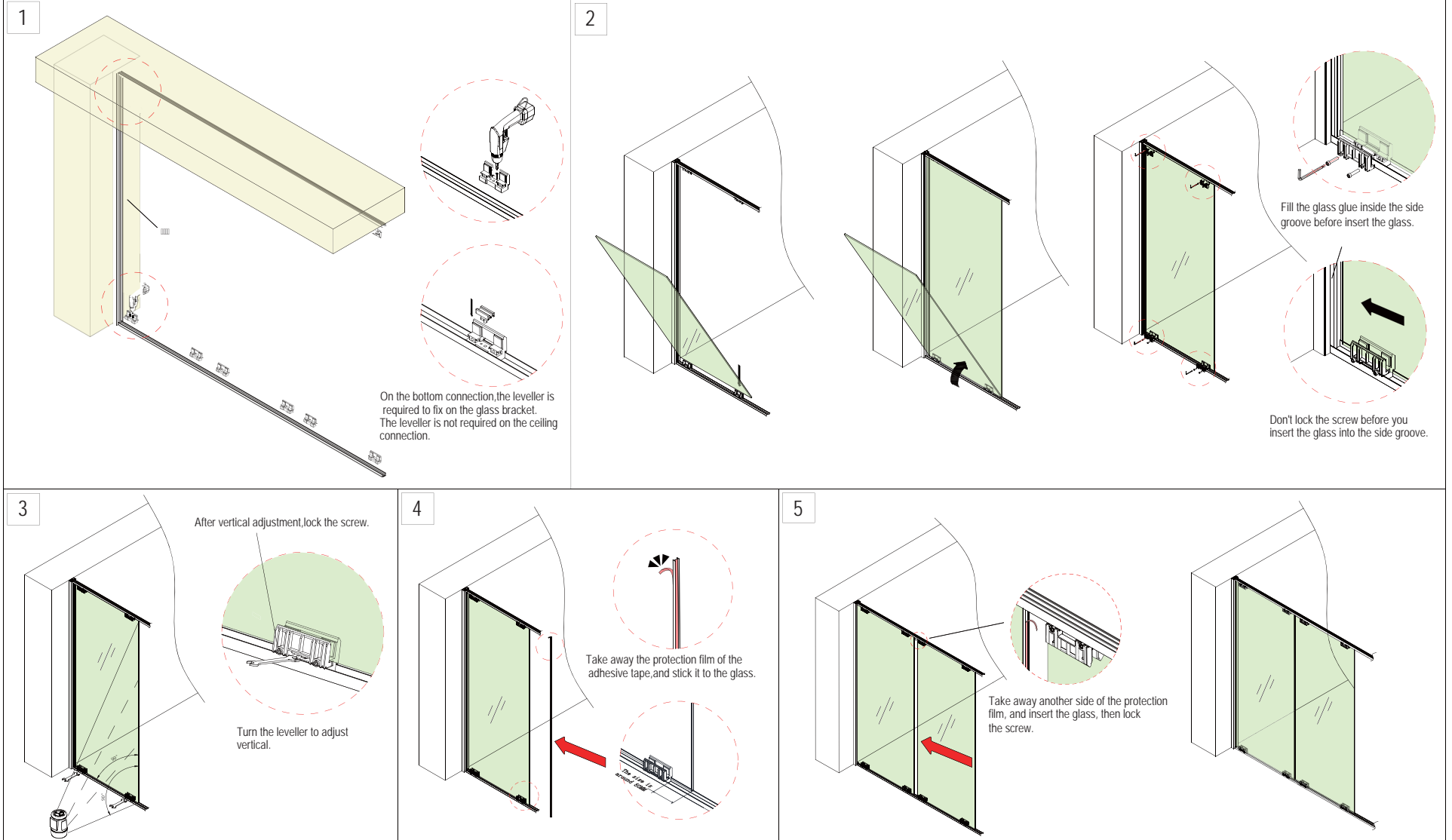

3.3.2 Connection and adjustment between wood panels

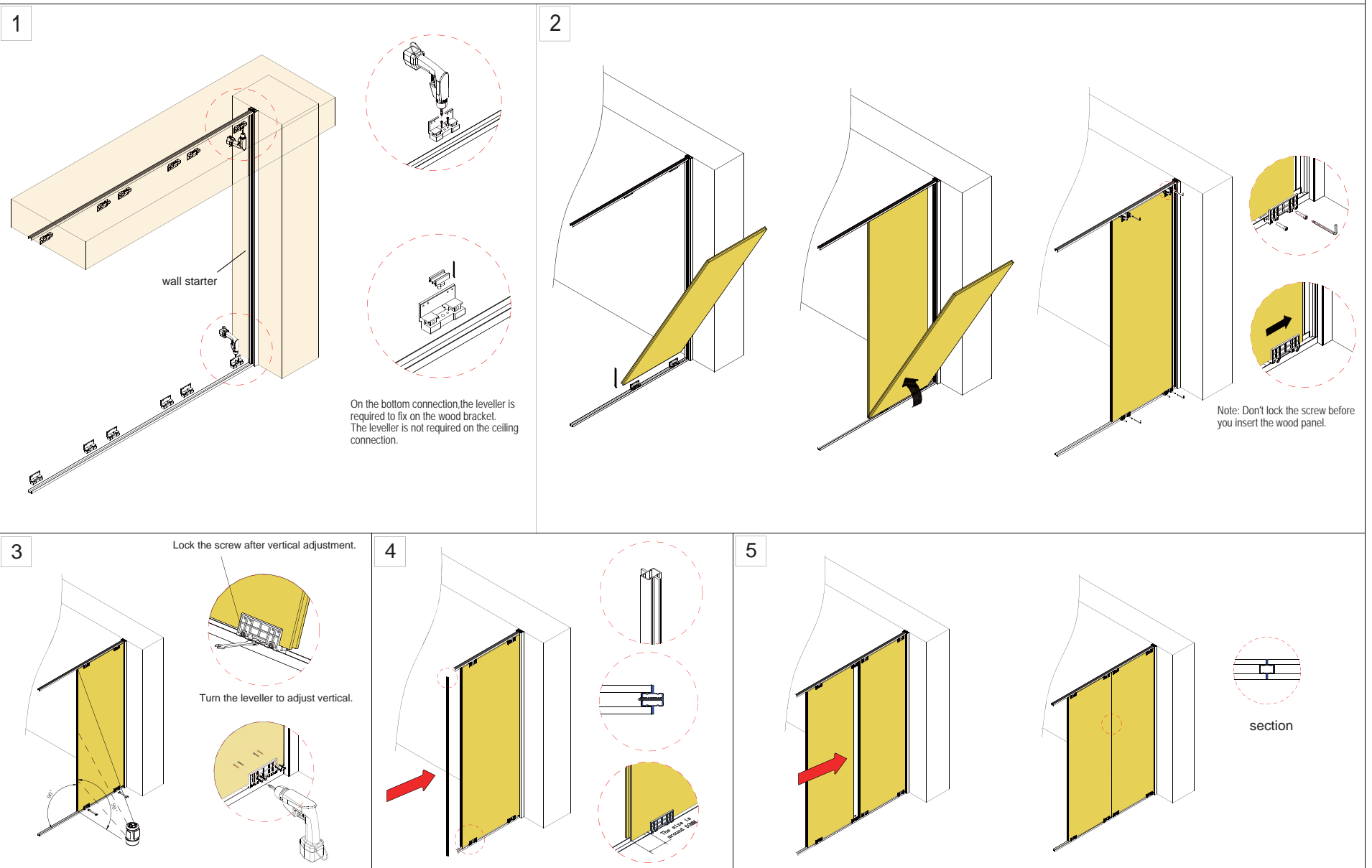

3.3.3 Connection and adjustment between wood panel and glass panel

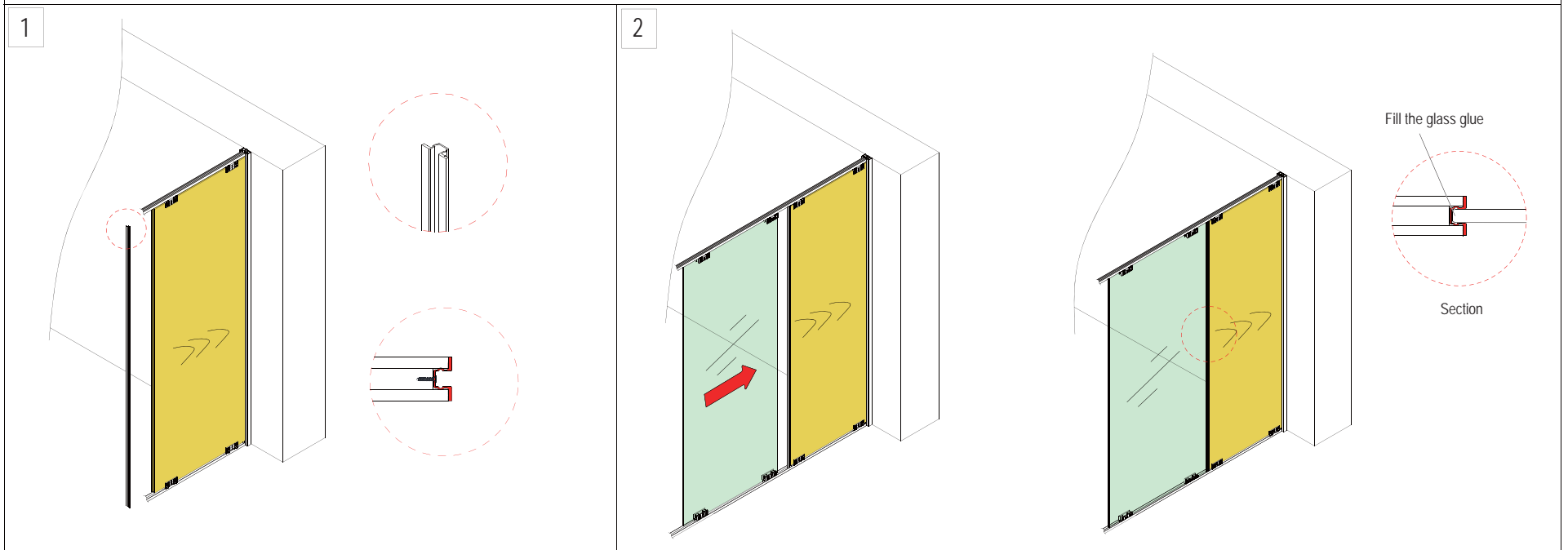

3.4 Cover fixing for top and bottom connection

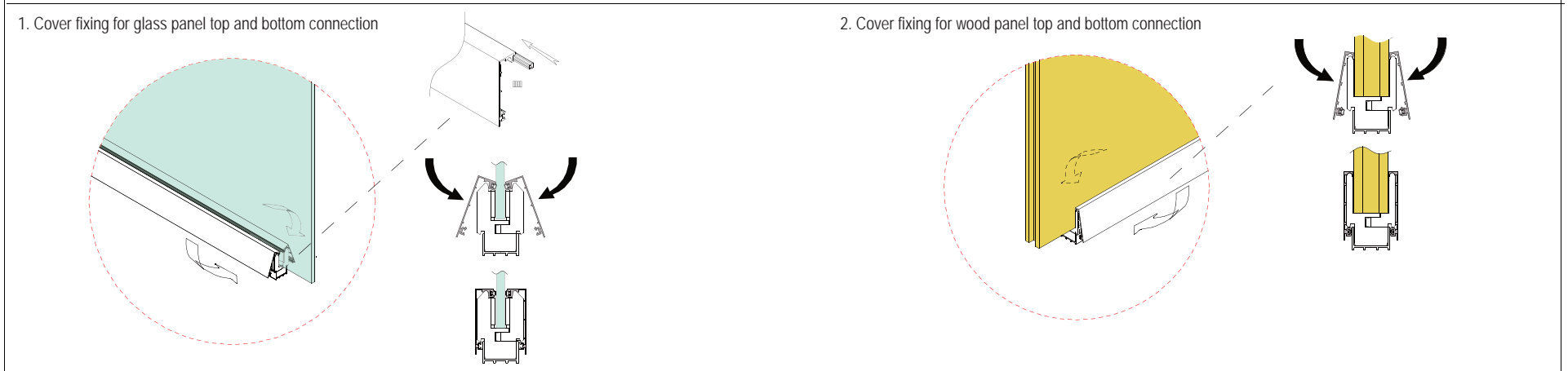

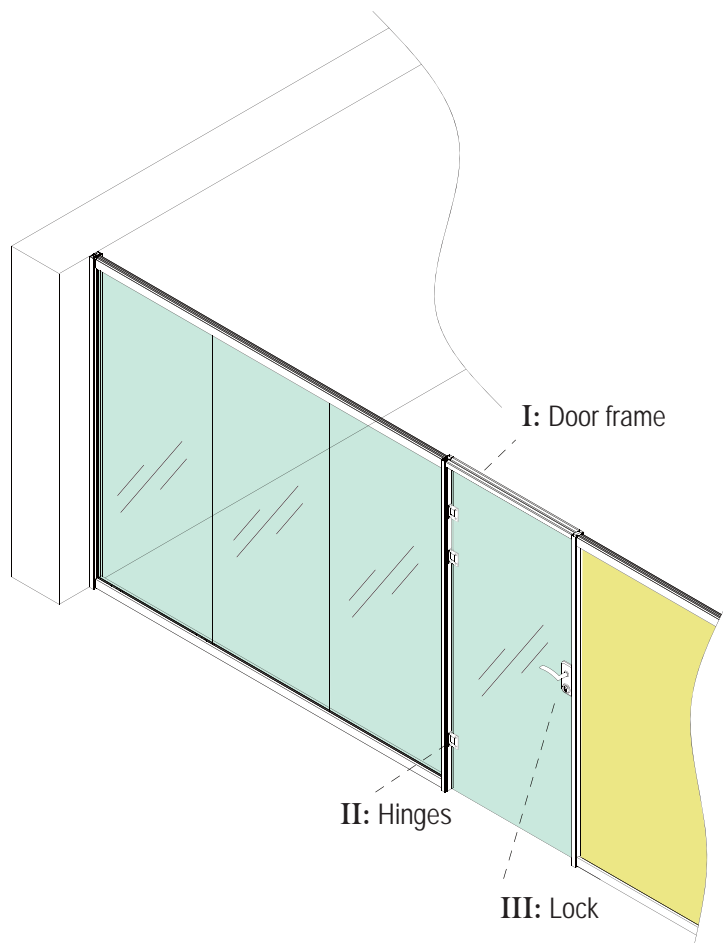

I: Door frame fixing

Step 1: fix the door frame with hinges

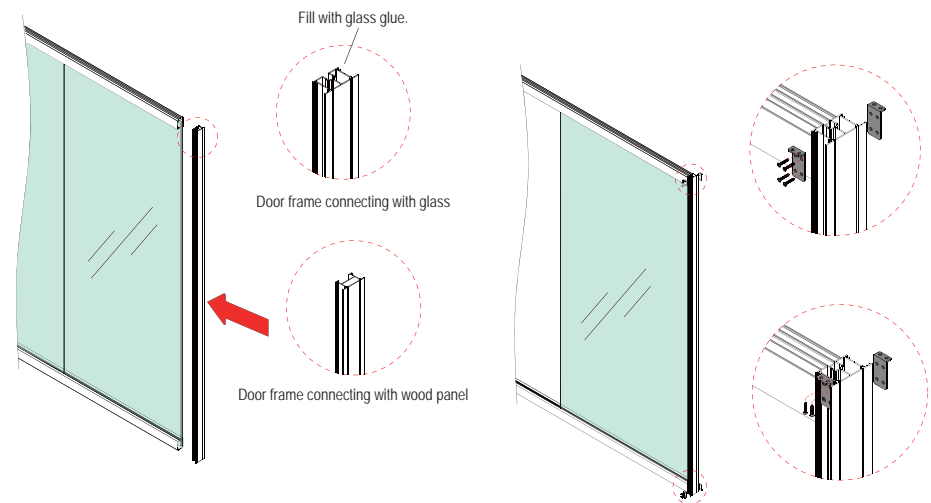

Step 2: fix the upper door frame

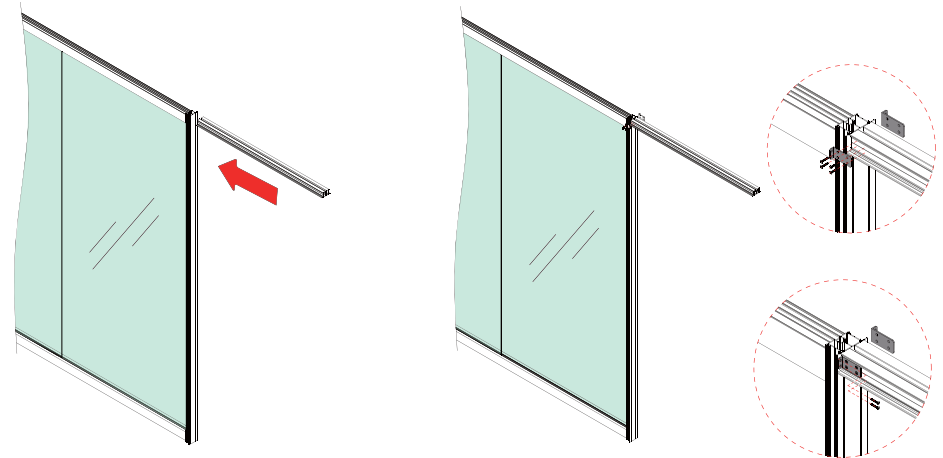

Step 3: Fix the door frame with lock

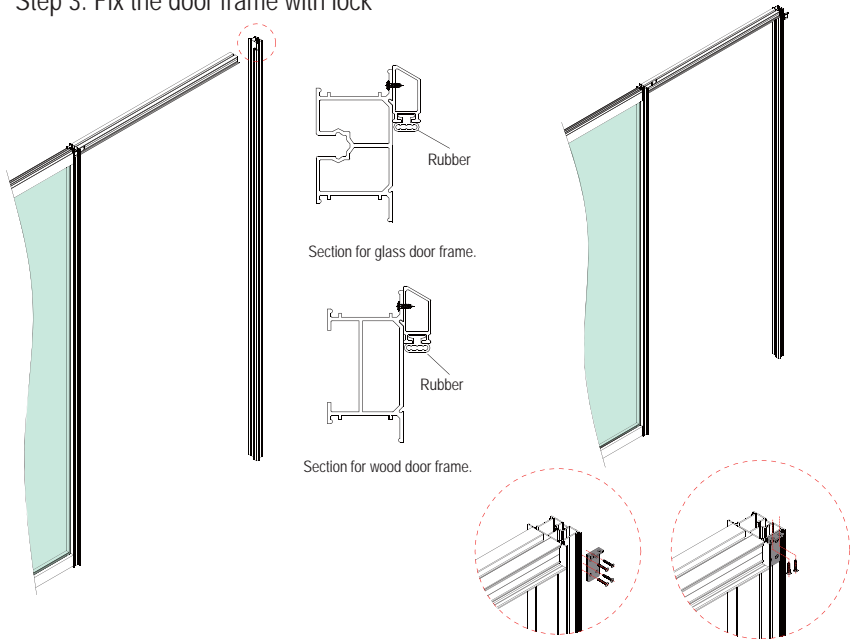

II: Hinges fixing

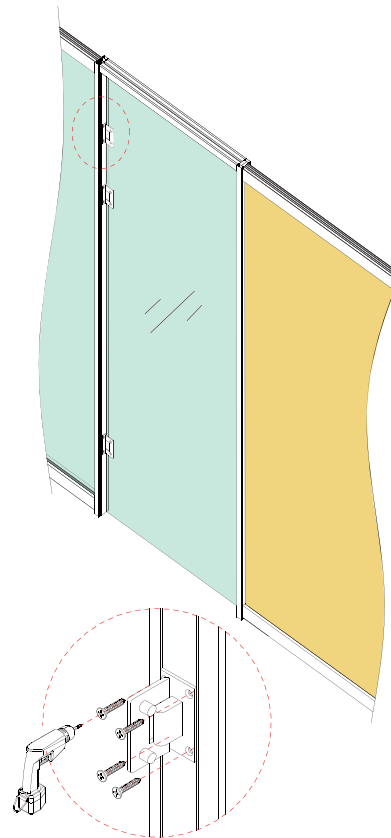

Plastic mat (one inside, one outside)

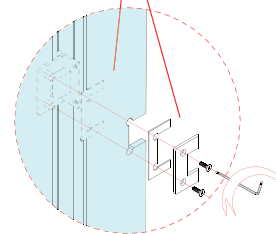

III: Lock fixing

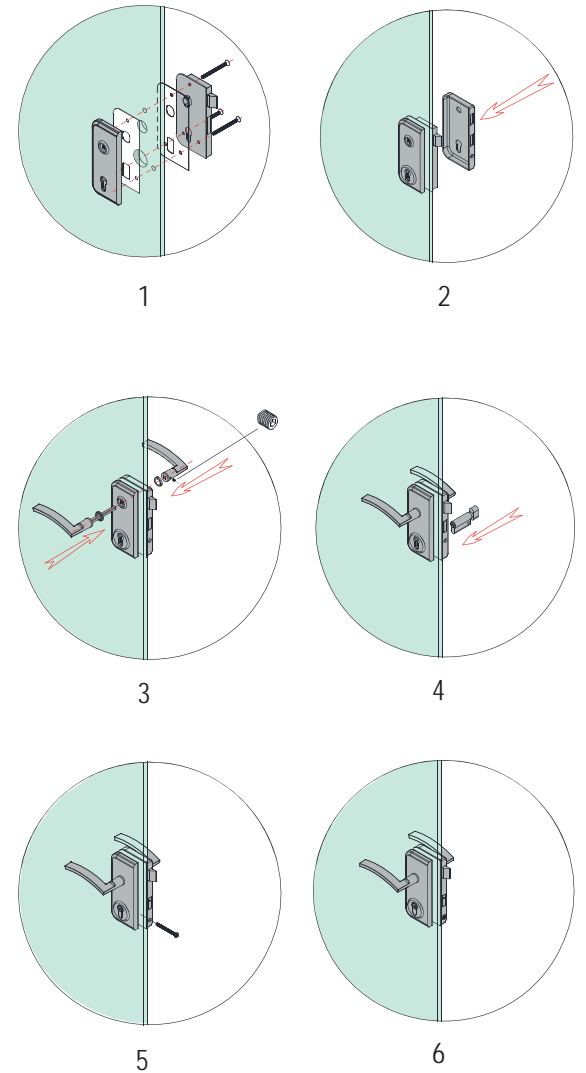

Step 4: fix the door frame cover

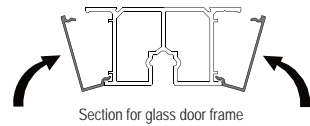
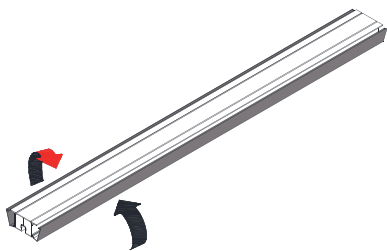

Section for glass door frame

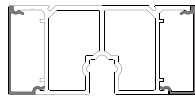

Section for wood door frame

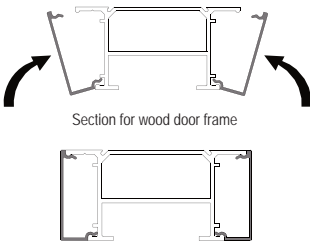

3.6 | Special place fixing

3.6.1: T connection

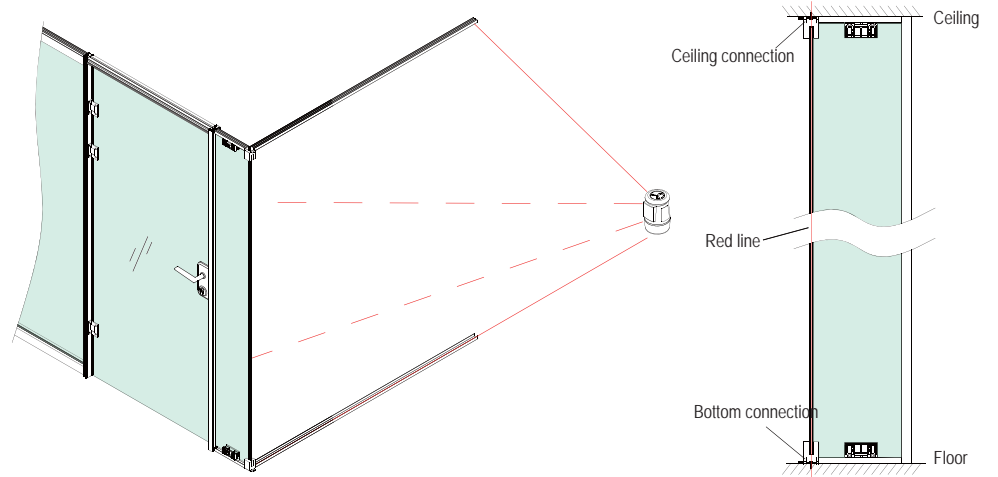
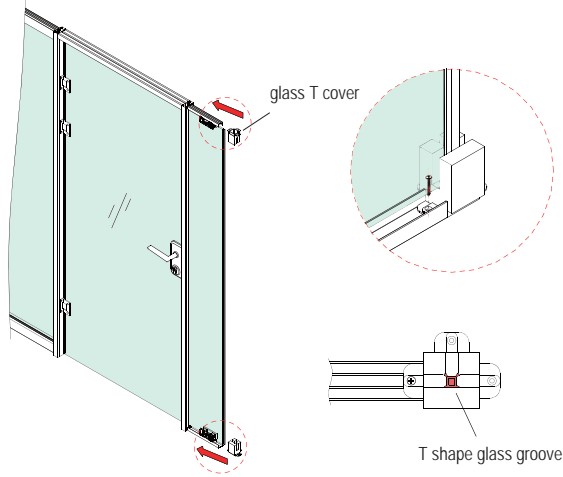
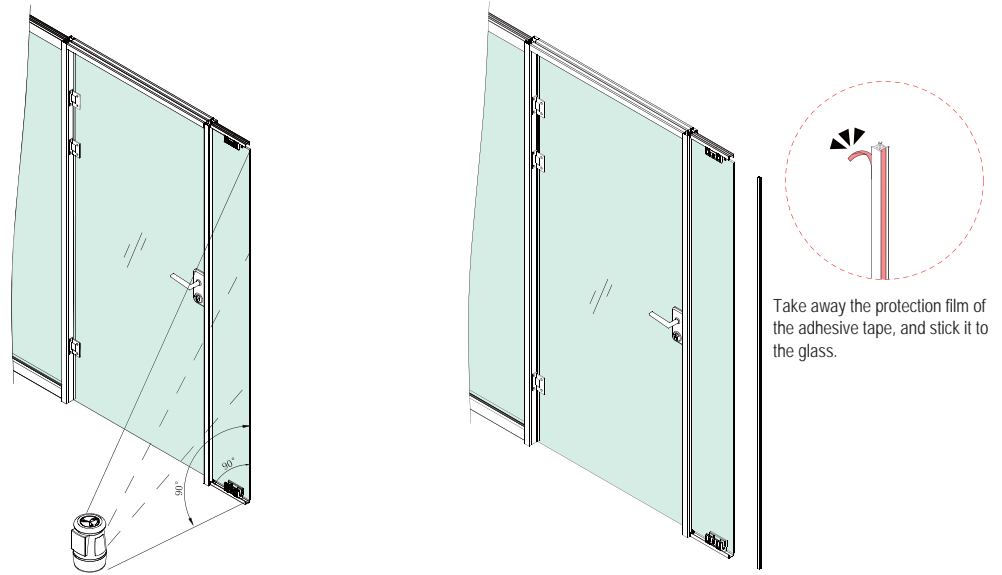
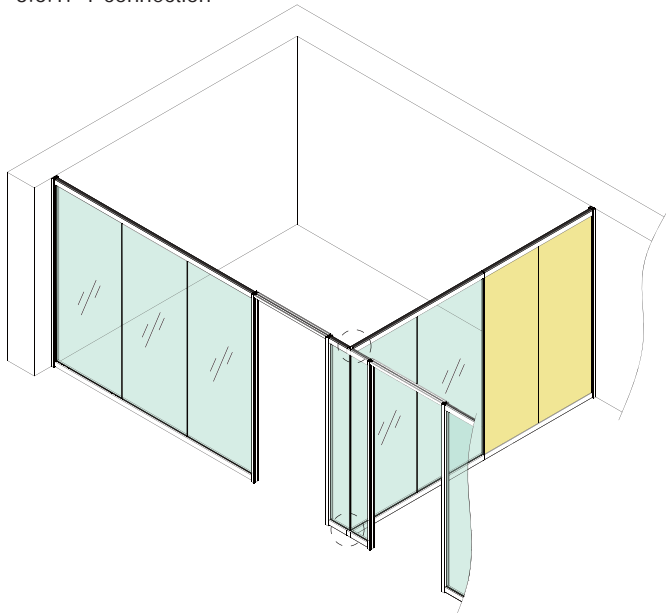

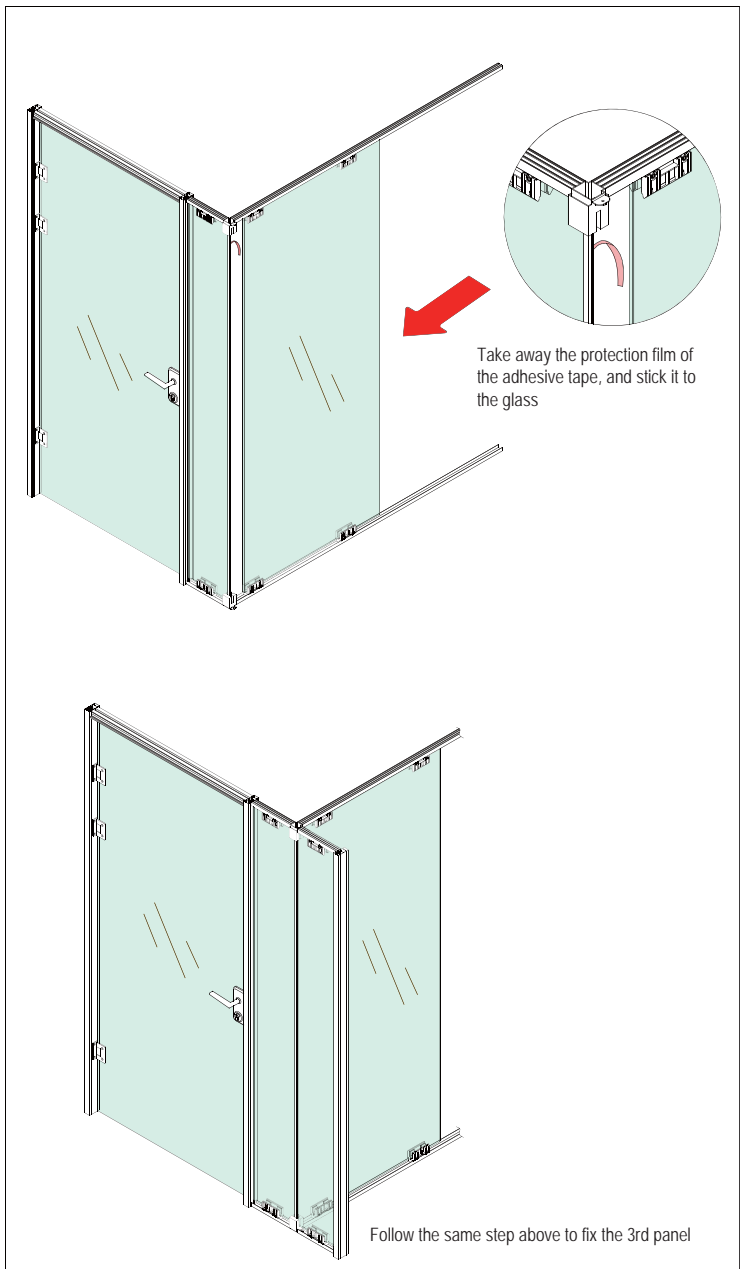

3.6.2: L connection

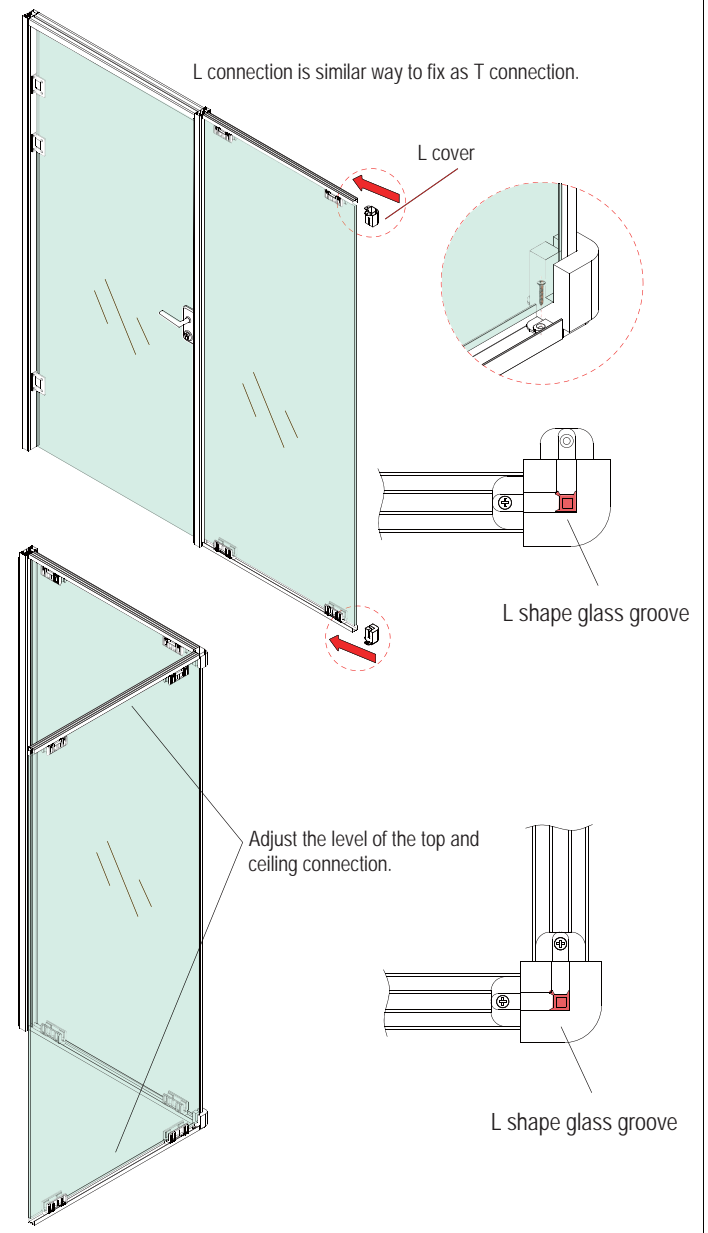
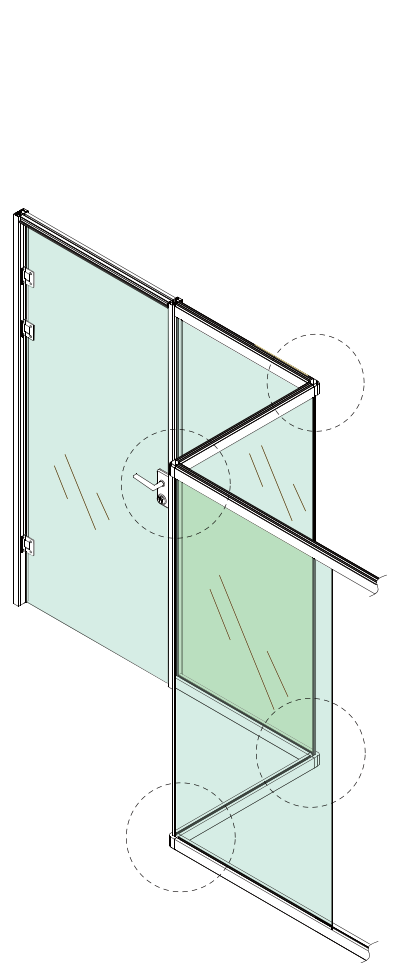

3.6.3: Wood panels corner

